

General tolerances ISO 2768-m						Index	Date	Visum	Modification	Index	Date	Visum	Modification
Basic-size	...6	> 6 ...30	> 30 ...120	>120 ...400	> 400 ...1000								
medium	±0.1	±0.2	±0.3	±0.5	±0.8								

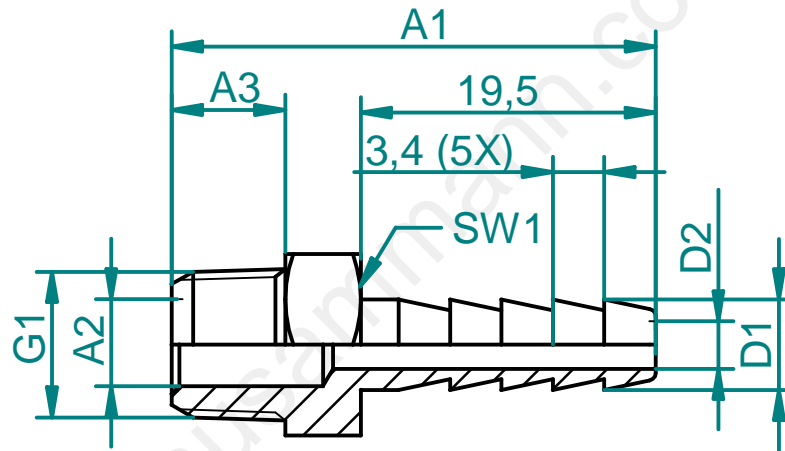

Specifications points D,K,H	
D= doc.points	
K= critical	
H= main	

		Material:			
		Messing vernickelt			
		Scale			
		<b>2:1</b>			
		Date		Date	
		11.04.11		E.Z	
		checked			
		38.481		Format	
				Index	
		<b>Solid Edge</b>		<b>A4</b>	
				<b>00</b>	
Accord-draw.no.:		© 2010, Für dieses Dokument behalten wir uns alle Rechte vor.		© 2010, Nous nous reservons tous les droits sur ce document	
Origin-draw.no.:		© 2010, We reserve all rights in connection with this document			
Replacement for:					

